

REMOVABLE TOP AND BOTTOM CAPS PROVIDE 180° ROTATION

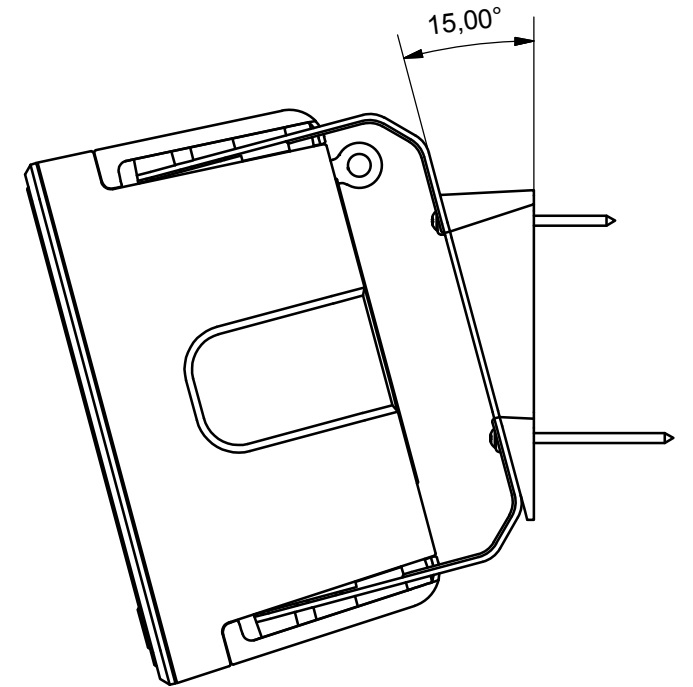

WITH OPTIONAL ANGLE BLOCK

CL50

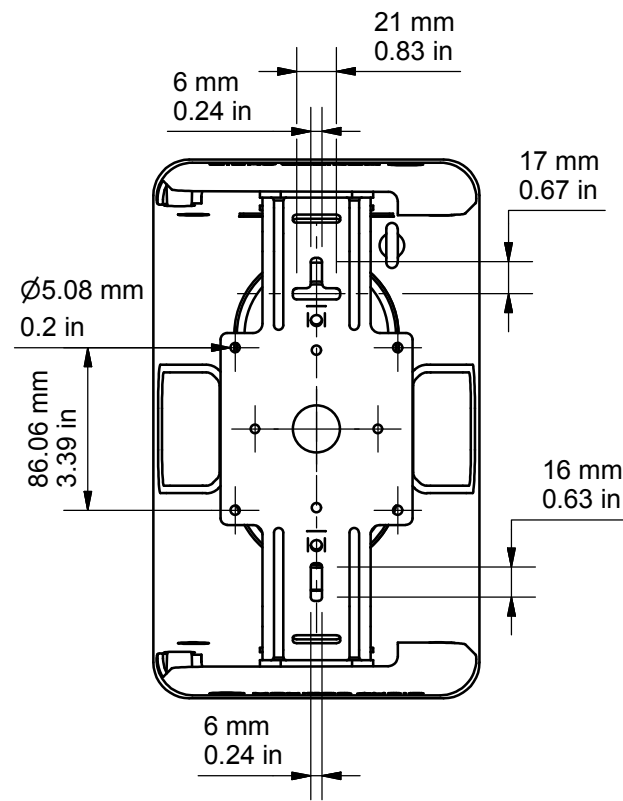
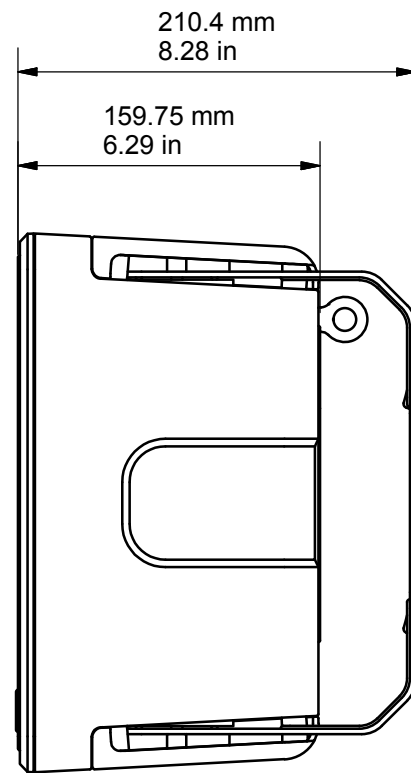
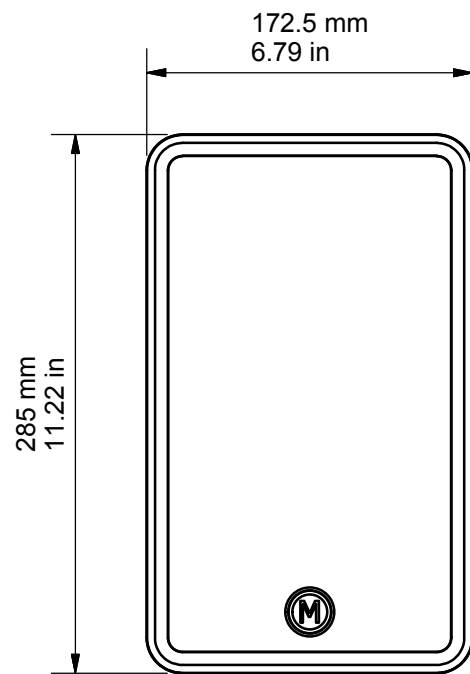

RANGE: CLIMATE

© COPYRIGHT MONITOR AUDIO

07/05/2015

